

Terminal Blocks - Single Row

Series A2000, LP2000 & CB2000

Single Row Terminal Blocks

SPECIFICATIONS

Rating: A2: 30A, 300V*

LP2: 30A, 150V*

CB2: 30A, 300V*

Center Spacing: 0.375" or 3/8" (9.52mm)

Wire Range: #12-22 AWG CU

Screw Size: #6-32 zinc-plated phillslot

Torque Rating: 9 lb-in.

Base: Standoffs standard for easy flux washing

Distance Between Barriers: 0.32" (8.1mm)

Recommended PCB Hole Diameter: 0.076" (1.93mm)

Operating Temperature: 105°C (221°F) max., -40°C (-40°F) min.

Molded Material: Black, UL Rated 94V0 Thermoplastic

Breakdown Voltage: 3400V (A2 & LP2); 4100V (CB2).

Agency Information: UL File E62622, CSA File 47235;

IEC Compliance; CE Certified

*30A Rating achieved with a #10 copper wire crimped to a ring terminal.;
20A Rating without ring terminal.



Dimensions - in (mm)

A2000 & LP2000 Series

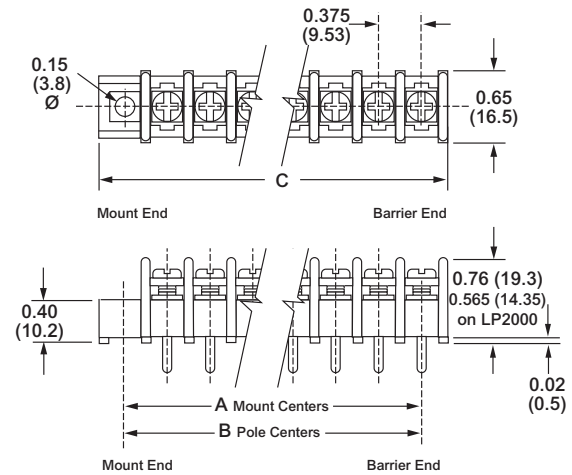

CB2000 Series

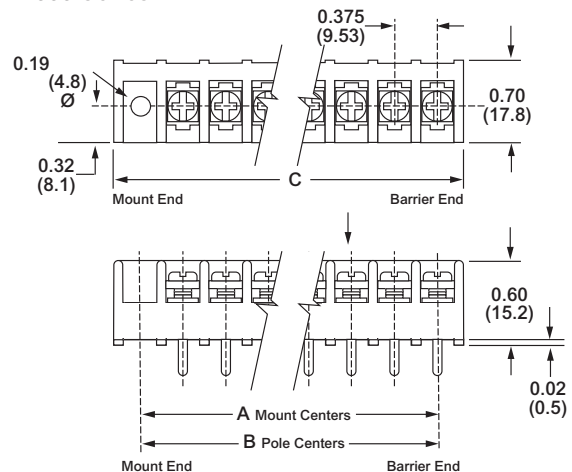

Poles	MOUNTING ENDS ONLY		BARRIER & MOUNTING ENDS B Pole Ctrs.	BARRIER ENDS ONLY C Length
	A Mount Ctrs.	C Length		
02	1.13	1.56	0.38	0.81
03	1.50	1.93	0.75	1.18
04	1.88	2.30	1.13	1.56
05	2.25	2.68	1.50	1.93
06	2.63	3.06	1.88	2.31
07	3.00	3.43	2.25	2.68
08	3.38	3.81	2.63	3.06
09	3.75	4.18	3.00	3.43
10	4.13	4.56	3.38	3.81
11	4.50	4.93	3.75	4.18
12	4.88	5.31	4.13	4.56
13	5.25	5.69	4.50	4.93
14	5.63	6.06	4.88	5.31
15	6.00	6.43	5.25	5.68
16	6.38	6.81	5.63	6.06
17	6.75	7.18	6.00	6.43
18	7.13	7.56	6.38	6.81
19	7.50	7.93	6.75	7.18
20	7.88	8.31	7.13	7.56
21	8.25	8.68	7.50	7.93
22	8.63	9.06	7.88	8.31
23	9.00	9.43	8.25	8.68
24	9.38	9.81	8.63	9.06
25	9.75	10.18	9.00	9.43
26	10.13	10.56	9.38	9.81
27	10.50	10.93	9.75	10.18
28	10.88	11.31	10.13	10.55
29	11.25	11.68	10.50	10.93
30	11.63	12.05	10.88	11.31
31	-	-	11.25	11.68
32	-	-	11.63	12.05

* Dimensions in inches. To convert to millimeters, multiply by 25.4.

Series A2000 & LP2000 Single Row Terminal Blocks

Part Numbering System

Series	Terminal Style	Base/End	Poles	Screw Options	Options
A2					
LP2					
A2 - standard barrier LP2 - low profile barrier	01 - handwired 02 - printed circuit 03 - non feed-thru 04 - wire wrap tail 05 - extended handwired 06 - handwired 07 - extended pin 08 - printed circuit 09 - 0.250" QC short 10 - 0.187" QC 14 - printed circuit 19 - 0.250" QC long	0 - flat base/molded mount end 1 - flat base/mnt. end 2 - flat base/barrier end 3 - insulator base/mnt. end 4 - insulator base/barrier end 5 - closed base/mount end 6 - closed base/molded mount end 9 - insulator base/molded mount end Base/End Note: 0, 6, 9 styles not available with covers. 5 & 6 Styles only available with 03 terminals.	02 to 32 02 to 30 on mount end base	Blank - std. screw 00 - screws shipped bulk 03 - stainless steel 04 - brass nickel-plated 07 - steel SEMS (not available with hardware options) 09 - brass SEMS nickel-plated (not available with hardware options) CA - captive screw WR - wire ready (not available on LP2 series)	AB - angle mnt. options (pg 9) A1 to A9 - 0.250" QC B1 to B9 - 0.187" QC DR - drilled right angle (pg 9) †JA, JB & JC - barrier jumpers L1 to L6 marking options (pg 22) MP, MP8 & MT mounting plates (pg 9) †OJ2 & OJ4 - over barrier jumpers (not available w/covers) RC - retaining clips (pg 9) R30 to R77 - right angle bends (pg 9) SO - stand off insulators (pg 9) S1 - solder lug/flat Covers - (pg 23)

†Contact factory for configuration..

Terminal Styles

Inches (Millimeters)

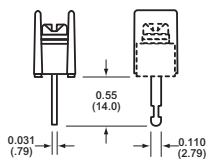

01
Handwired

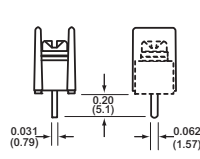

02
Printed Circuit



03
Non Feed-Thru

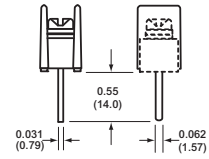

04
Wire Wrap Tail

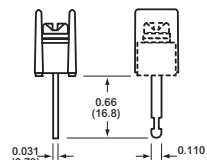

05
Extended Handwired

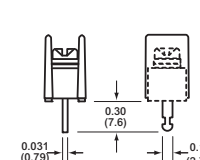

06
Handwired

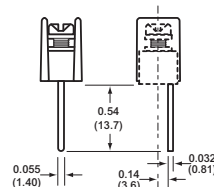

07
Extended Pin

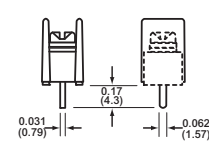

08
Printed Circuit

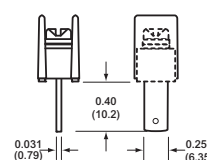

09
0.250" QC short

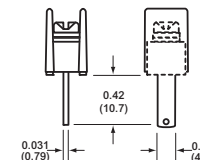

10
0.187" QC

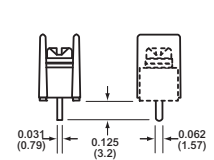

14
Printed Circuit

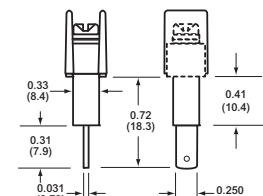

19
√0.250" QC long

Terminal Blocks - Single Row

Series A2000 & LP2000 Single Row Terminal Blocks *Continued*

Screw Options

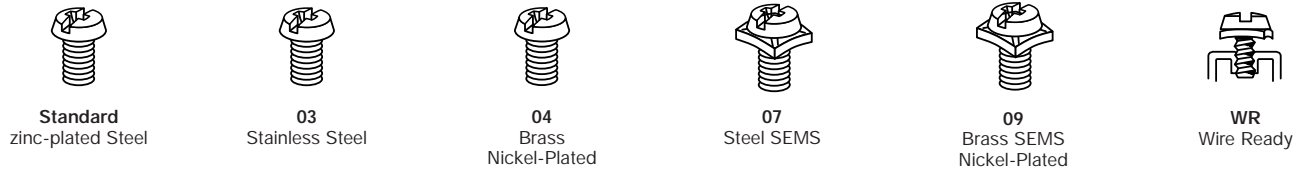

Hardware Options (Bulk ordering part numbers are in parentheses.)

Inches (Millimeters)

Solder Lugs

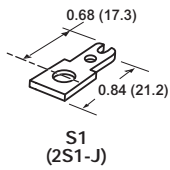

Jumpers

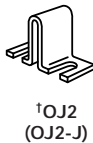
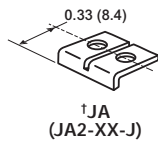

Quick Connects

Blade Width A = 0.250" Blade Width B = 0.187"

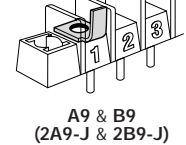
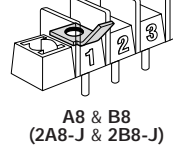
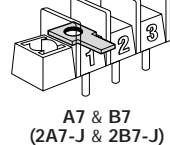
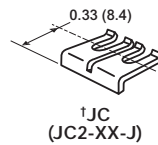
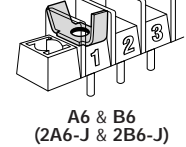
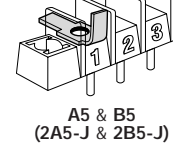
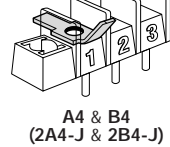
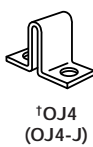
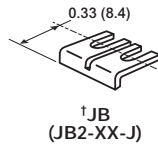
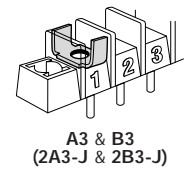
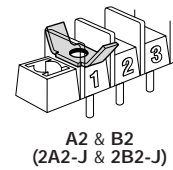
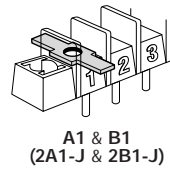

†Contact factory for configuration.

Base/End Options

Inches (Millimeters)

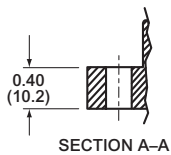
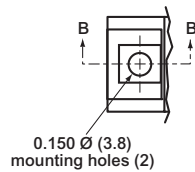
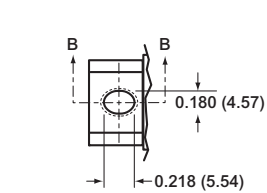

0, 6 & 9
Molded Mount End

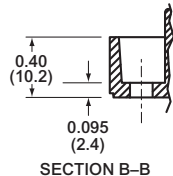

1, 3 & 5
Mount End

Series A2000 & LP2000 Single Row Terminal Blocks *Continued*

Mounting Options

Right Angle Bends (A2, LP2 only)

Right angle terminals are offered on the A2000 & LP2000 Series. Configurations are defined in these dimensions: X = pin extension beyond the block base; Z = length from block base to centerline of the terminal tip. Standard bends consist of the X and Z dimensions shown in the chart. Specify by adding the selected Bend Option Code to the terminal part number.

04 Terminal Bend Configurations

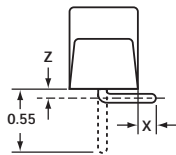

Bend Option Code	X (minimum)	Z	Available w/insulator base
R30	0.04	0.28	No
R35	0.01	0.23	No
R36	0.02	0.22	No
R39	0.05	0.19	No
R42	0.08	0.16	No
R46	0.12	0.12	No
R48	0.14	0.10	No
R50	0.16	0.08	No

07 Terminal Bend Configurations

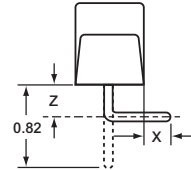

Bend Option Code	X (minimum)	Z	Available w/insulator base
R30	0.04	0.55	Yes
R35	0.01	0.50	Yes
R36	0.02	0.49	Yes
R42	0.08	0.43	Yes
R46	0.12	0.39	Yes
R50	0.16	0.35	No
R53	0.19	0.32	No
R66	0.32	0.19	No
R69	0.35	0.16	No
R75	0.41	0.10	No
R77	0.43	0.08	No

Dimensions in inches. To convert to millimeters, multiply by 25.4.

Angle Brackets (A2, LP2 only)

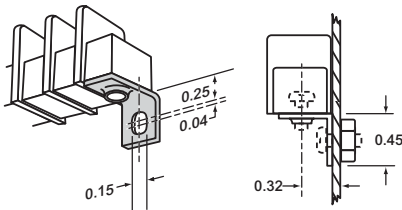

Option AB

Angle brackets enable block to be fastened at right angles to normal mount position. Bulk part number **2AB-J**.

Drilled Right Angle (A2, LP2 only)

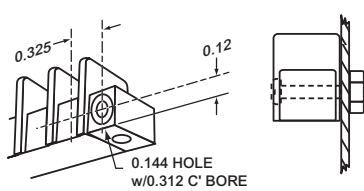

Option DR

Counterbored holes across mount ends of block enable fastening with two screws at right angles to normal mount position.

Mounting Plates

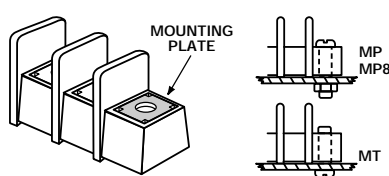

Options MP, MP8 & MT

MP Metal inserts with 0.150" dia. hole accept #6 screw. **MP8** Metal inserts with 0.187" dia. hole accept #8-32 screw. **MT** Metal inserts with tapped hole accept #6-32 screw.

Standoffs

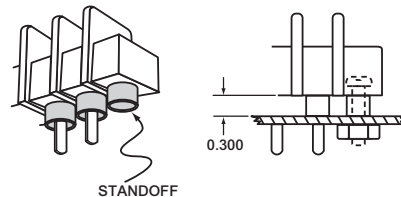

Option SO

Standoff mounts are tubes molded to the mounting positions. Available with insulator bases only.

Retaining Clip

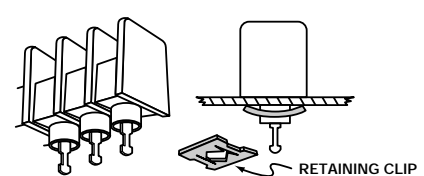

Option RC

Use on standoff tubes. Fit panels up to 0.125" thick. Two clips for every five positions. Supplied unassembled. Bulk part number **H541-J**.

Terminal Blocks - Single Row

Series CB2000

Single Row Terminal Blocks

Part Numbering System

Series	Terminal Style	Base/End	Poles	Screws	Options
CB2					
CB2 - closed back	01 - handwired 02 - printed circuit 03 - non feed-thru 07 - extended pin 14 - printed circuit 22 - dual tail printed circuit	1 - mount end 2 - barrier end	02 to 32 02 to 30 on mount end base	03 - stainless steel 04 - brass nickel-plated 07 - steel SEMS standard 09 - brass SEMS nickel-plated CA - captive screw 07CA - SEMS captive	*AB - angle mounting brackets (pg 11) A7 to A9 - 0.250" QC B7 to B9 - 0.187" QC EB - exit back terminals EF - exit front terminals †JA, JB & JC - barrier jumpers L1 to L6 marking options (pg 22) LT1 to LT6 marking options (pg 22) †OJ2 & OJ4 - over barrier jumpers MP, MP8, MT & MT8 mtg. plates (pg 11) S1 - solder lug/flat

*Only available on 3-poles and up.
†Contact factory for configuration.

Terminal Styles

Inches (Millimeters)

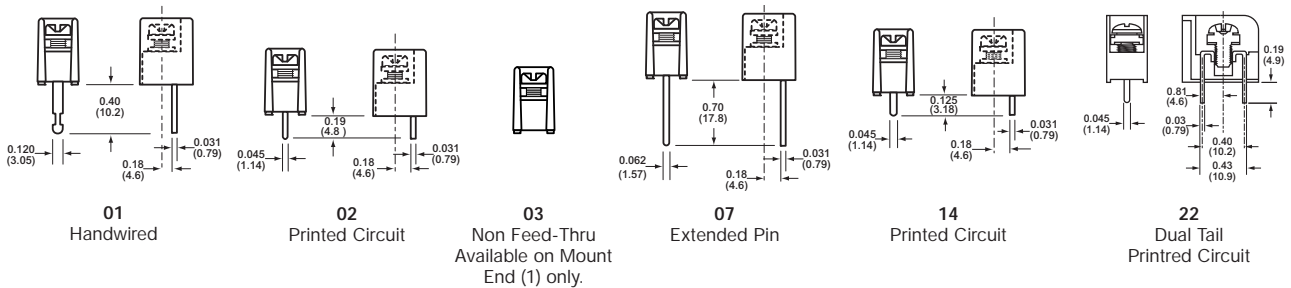

Screw Options (Bulk ordering part numbers are in parentheses.)

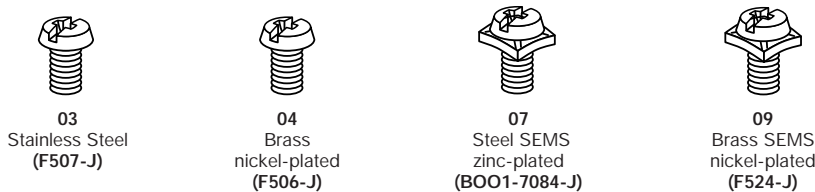

* NOTE: Wire ready screws standard on all terminal styles.

CB2 Terminal Exit Options

Inches (Millimeters)

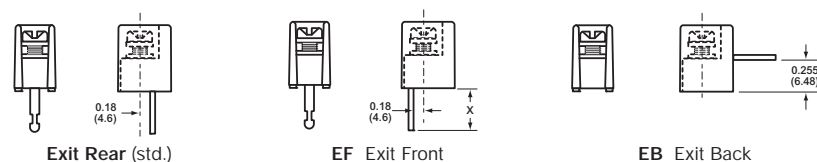

Series CB2000 Single Row Terminal Blocks

Hardware Options (Bulk ordering part numbers are in parentheses.)

Inches (Millimeters)

Solder Lugs

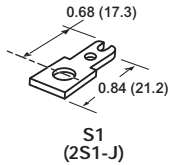

Jumpers

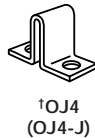
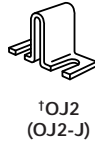
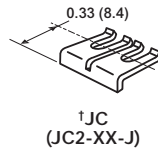
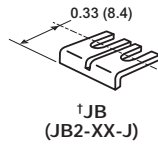
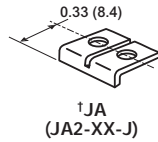

Quick Connects

Blade Width A = 0.250". Blade Width B = 0.187".

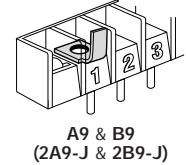
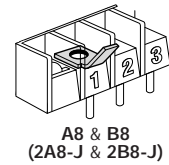
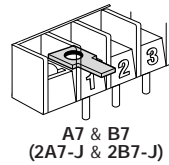

†Contact factory for configuration.

Mounting Options

Inches (Millimeters)

Right Angle Mounting Bracket

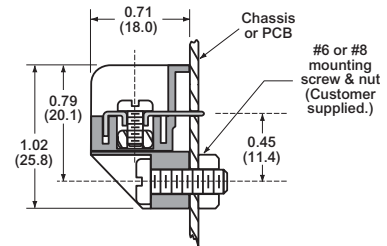
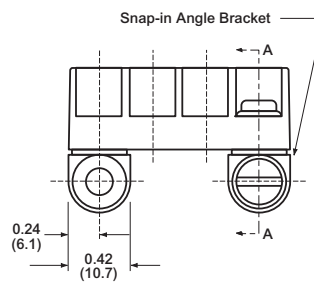
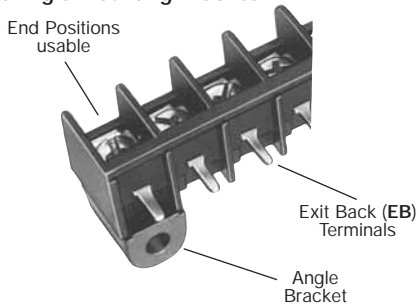

Mounts blocks on PC boards at a right angle.

- Protects solder joints.
- Recommended for all EB (Exit Back) PCB terminal blocks.
- Bracket snaps securely on block (no hardware required).
- Minimum strip length (end positions are usable).
- Mount with #6-32 or #8-32 screws (not supplied).

Option AB

Mounting Plates

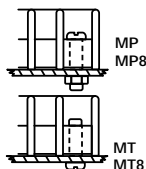
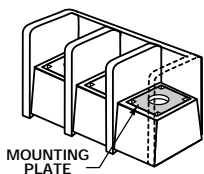

Options MP, MP8, MT & MT8

- MP Metal inserts with 0.150" dia. hole accept #6 screw.
- MP8 Metal inserts with 0.187" dia. hole accept #8-32 screw.
- MT Metal inserts with tapped hole accept #6-32 screw.
- MT8 Metal inserts with tapped hole accept #8-32 screw.